

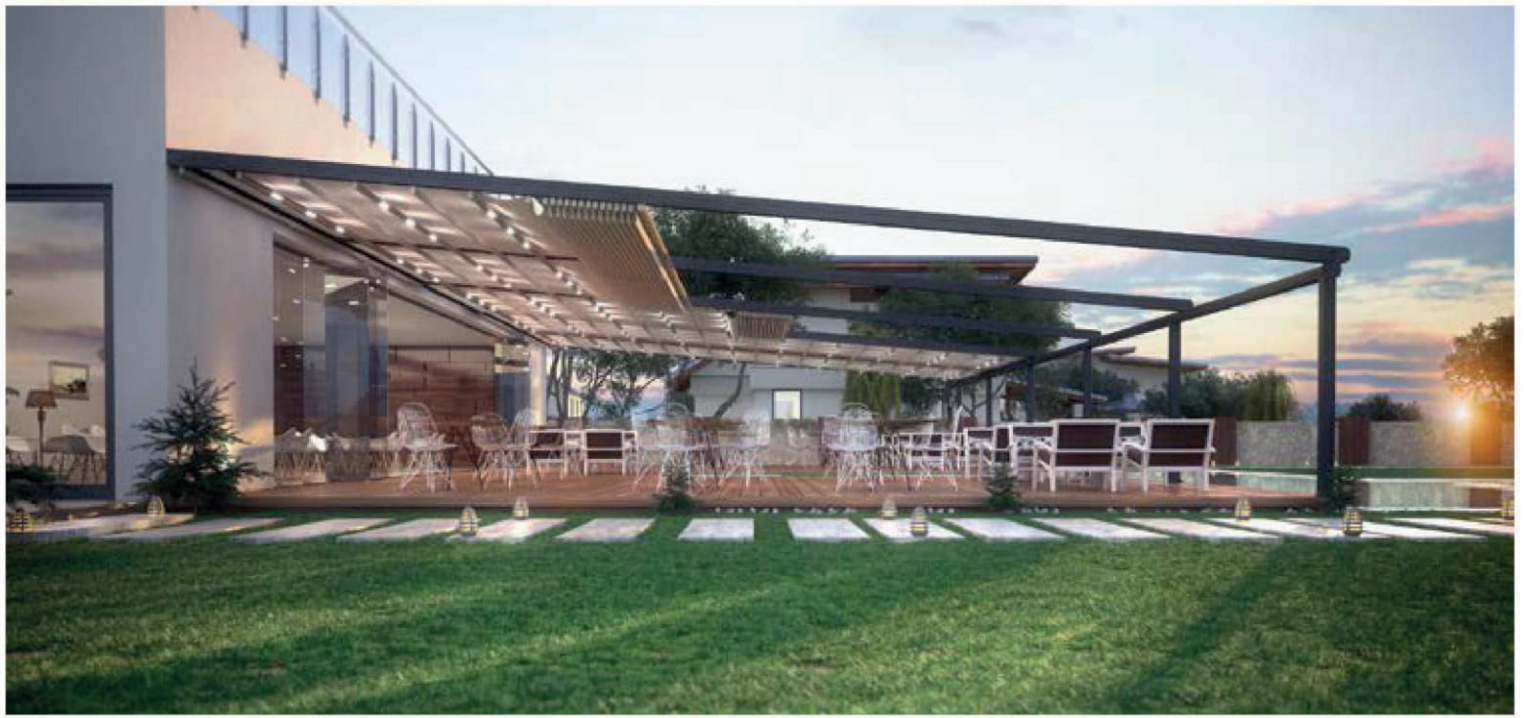

PERGOLA SYSTEM ADVANCE

Technical Information List

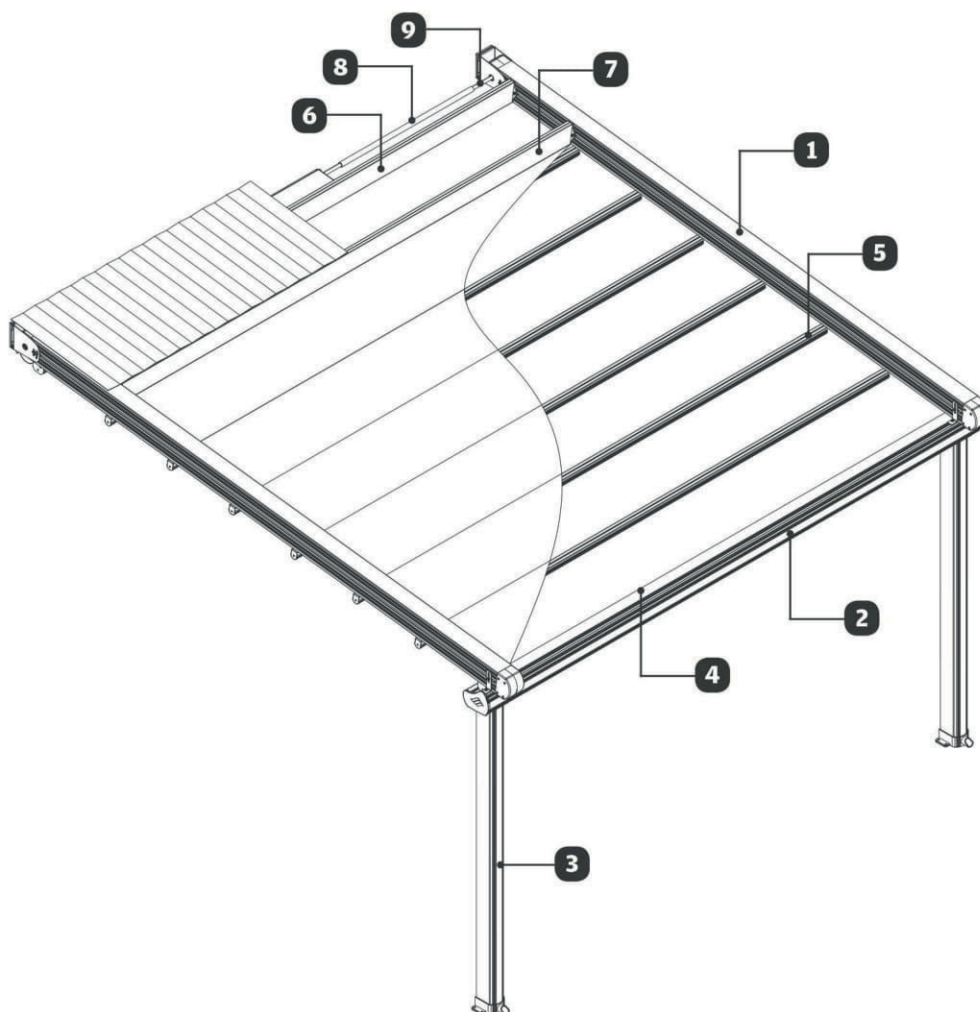



1 Rafter Profile

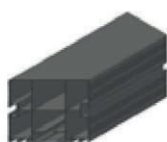
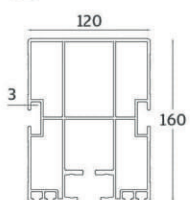

2 Gutter Profile

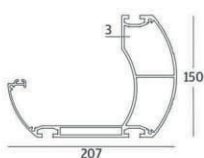

3 Carrier Post Profile

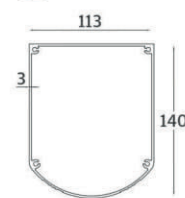

4 Fabric Profile | Master

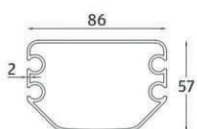

5 Fabric Profile | Carrier

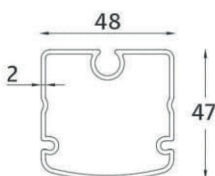

6 Motor Box Profile

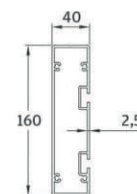

7 Roof Sash Profile

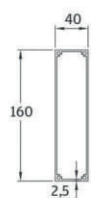

8 Motor Shaft Pipe Profile | Thick



9 Motor Shaft Pipe Profile | Thin



* All dimensions shown above are in millimeters.

Single Module

Max. Width as 4000
Standard Carrier Post Profile height as 2500



Double Module

Max. Width as 8000
Standard Carrier Post Profile height as 2500



Triple Module

Max. Width as 12000
Standard Carrier Post Profile height as 2500



Technical Side View



∇ Projection ^	Fabric Fall Height (H)	Hood Cover (L)	7° Degree Rule Fall Height (Y)	Fabric Profile Carrier
3000	542	710	680	7 pcs
3500	548	780	741	8 pcs
4000	554	850	803	9 pcs
4500	560	920	864	10 pcs
5000	566	990	925	11 pcs
5500	572	1130	987	12 pcs
6000	578	1200	1048	13 pcs
6500	584	1270	1109	14 pcs
7000	590	1340	1171	15 pcs
7500	596	1410	1232	16 pcs
8000	602	1480	1294	17 pcs
8500	608	1550	1355	18 pcs
9000	614	1620	1417	19 pcs
9500	620	1690	1478	20 pcs
10000	626	1760	1540	21 pcs

* Distances between fabric profiles had been calculated and measured as 50 cm and it may. Vary upon the measurement of each project therefore you are kindly requested to Contact your key account manager in order to avoid any misunderstanding other wise Rising shading systems will not be responsible for any mistakes that may occur.

* All dimensions shown above are in millimeters.

Fabric Colour Swatch



Somfy Wind Sensor



Somfy Wind and Sun Sensor



Somfy Rain Sensor



Rising Infrared Heater



Aluminium Powder Coating



Aerosol Touch-up Spray Paint



Bi-Metal Holesaw



Silicone



Packaging with Wooden Crate



Balcony Glass & Glazing Systems

pi pergola

pipergola.com

info@pipergola.com